

MONTERINGSANVISNING

IDT
GLASSKINNE
TOPPMONTERT

For tre og betong

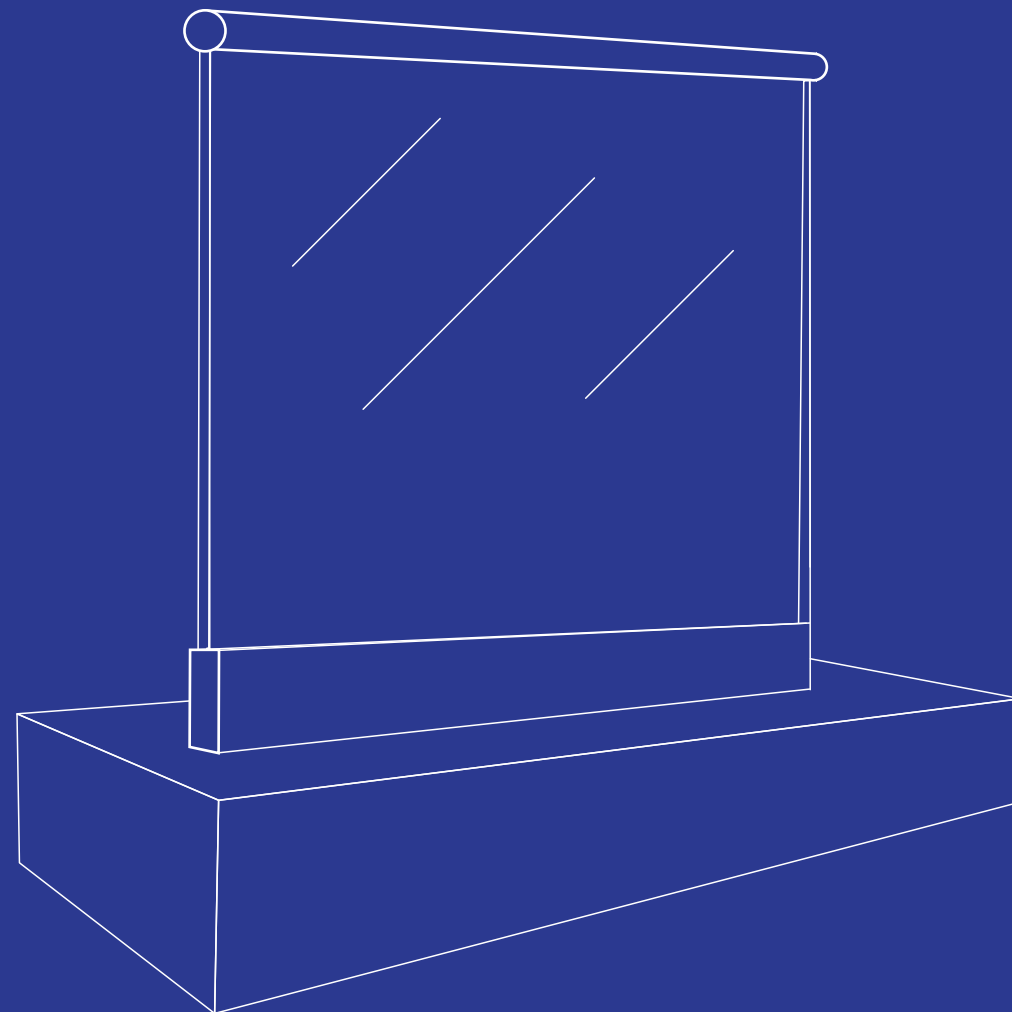



IDT GLASSKINNE TOPPMONTERT

1

Betong:
Mål til og bor hull
for enklere montering
av profil.

Treverk:
Krever ingen forboring.

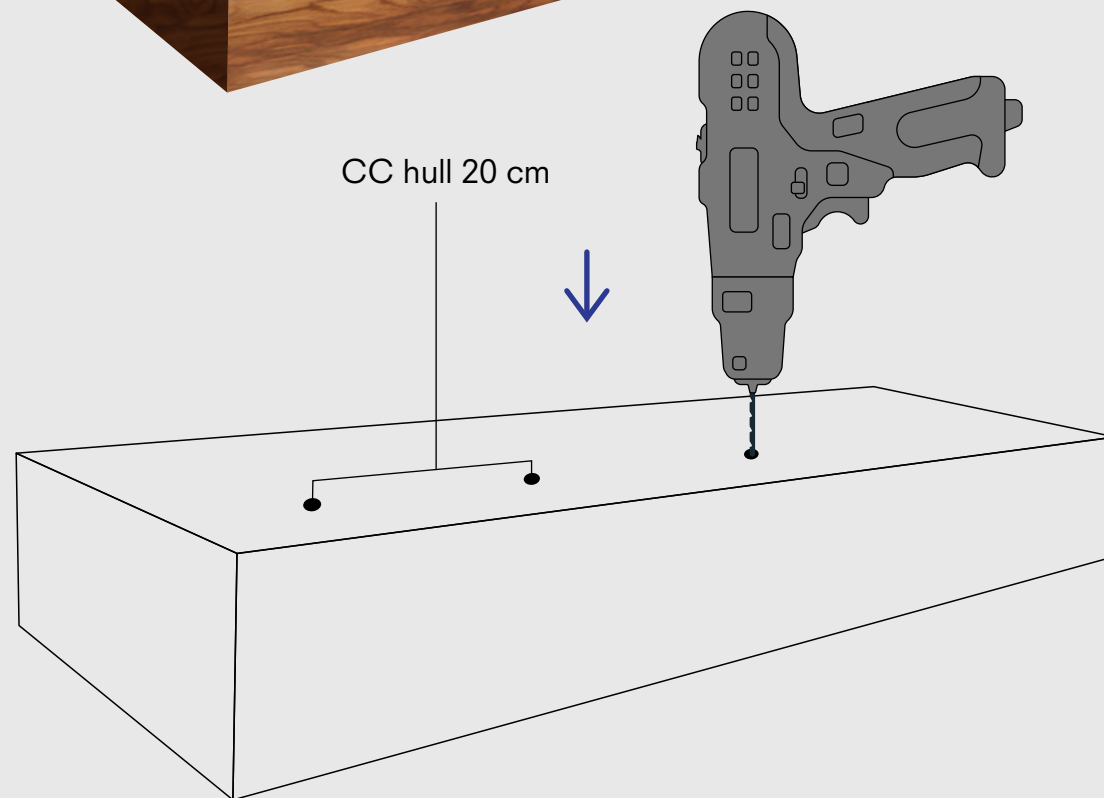

IDT GLASSKINNE

TOPPMONTERT

2

Fest aluminiumsprofilen med skruer.

Vær nøye og se til at profilener i lodd! Kiling må påregnes på skjevt underlag.

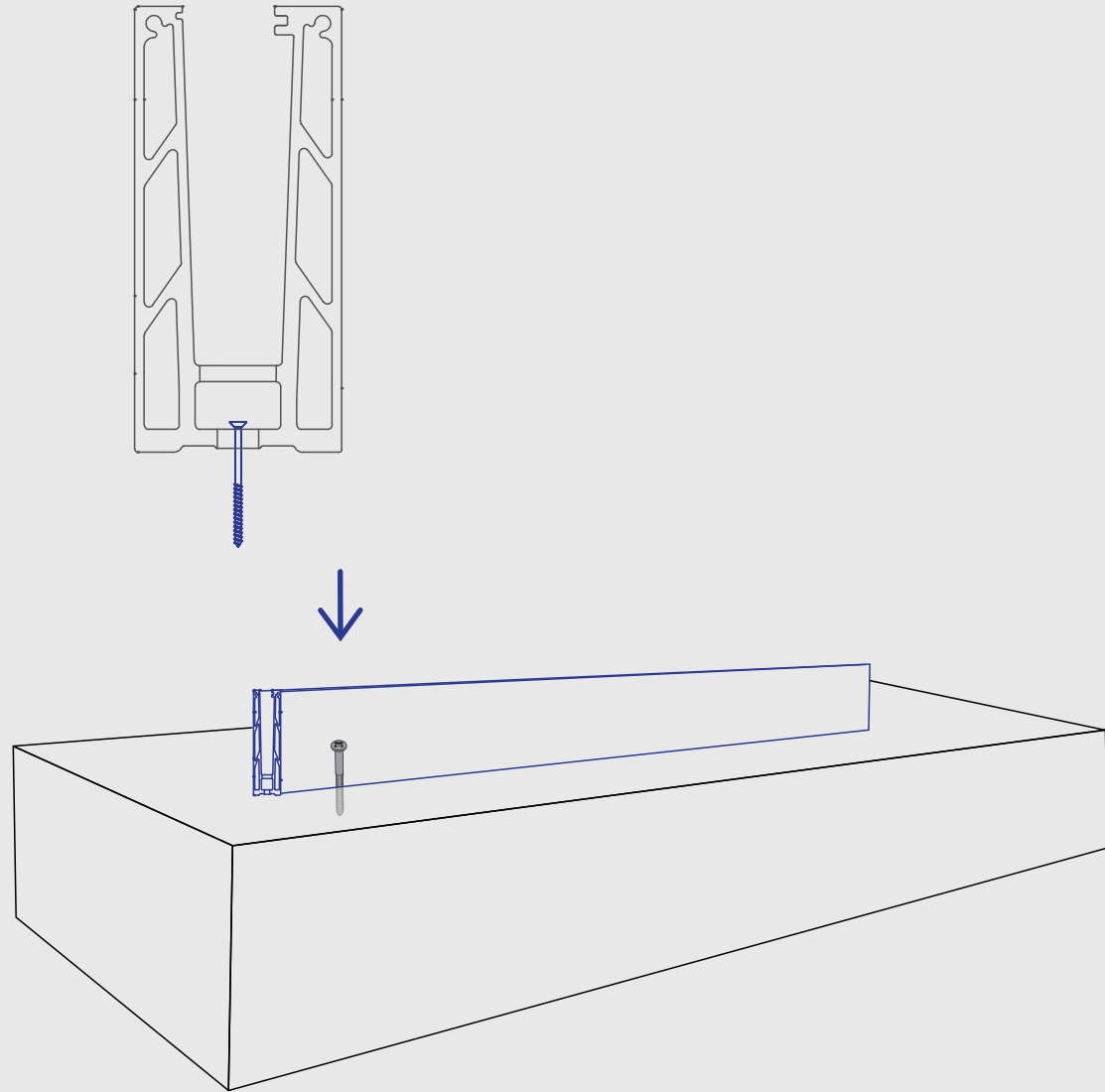
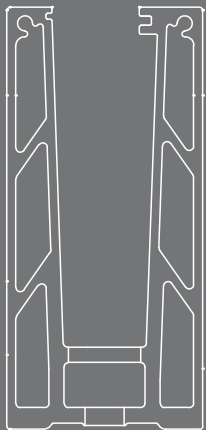

IDT GLASSKINNE TOPPMONTERT

3

Legg i u-klossen,
ca 4 per 1 meter.

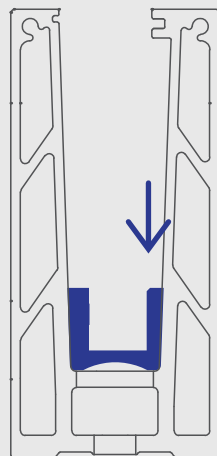

Se til at den tynne kanten
på u-klossen ligger mot
utsiden.

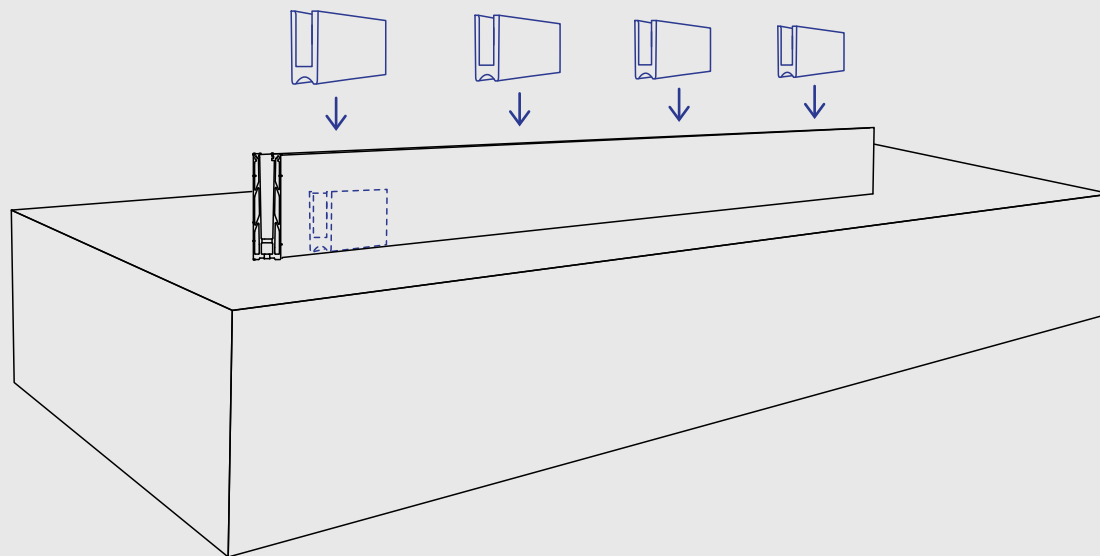

IDT GLASSKINNE TOPPMONTERT

5

Fest gummilist.
Ikke strekk gummlisten
under montasje!

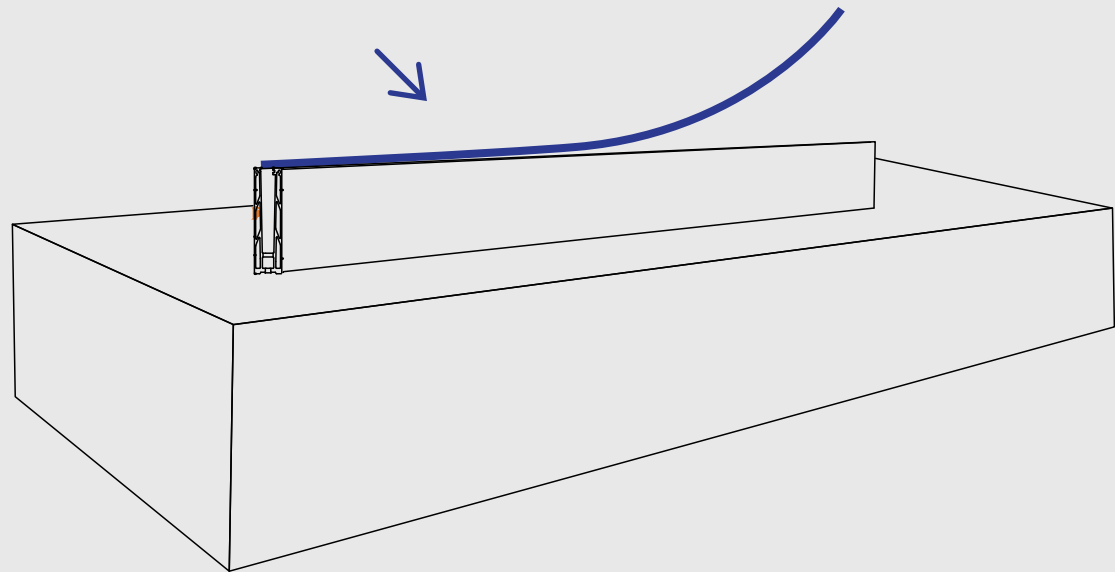
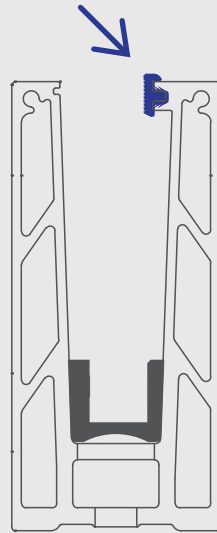

IDT GLASSKINNE TOPPMONTERT

6

Senk glasset forsiktig
på plass i u-klossene.

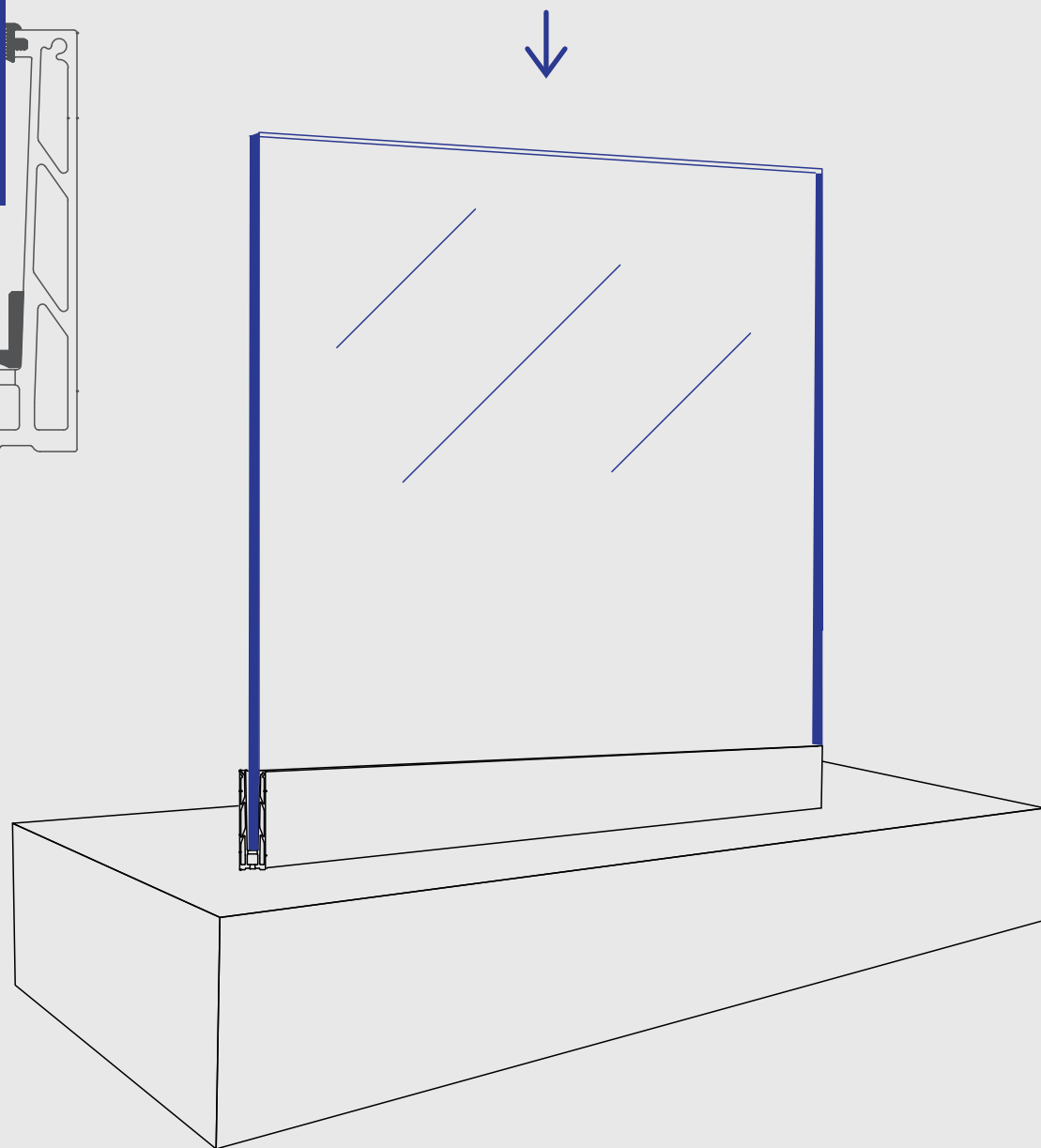
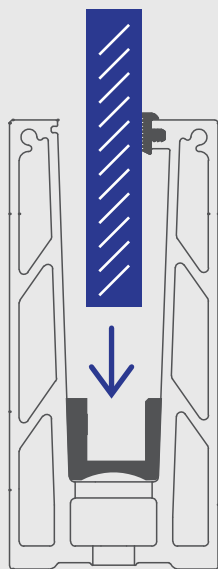
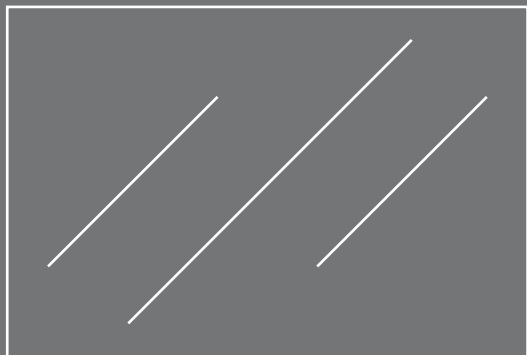

IDT GLASSKINNE TOPPMONTERT

7

Legg i kiler.
En kile per u-kloss.
Sentreres over u-kloss.
Slås ned til de møter
u-klossen.

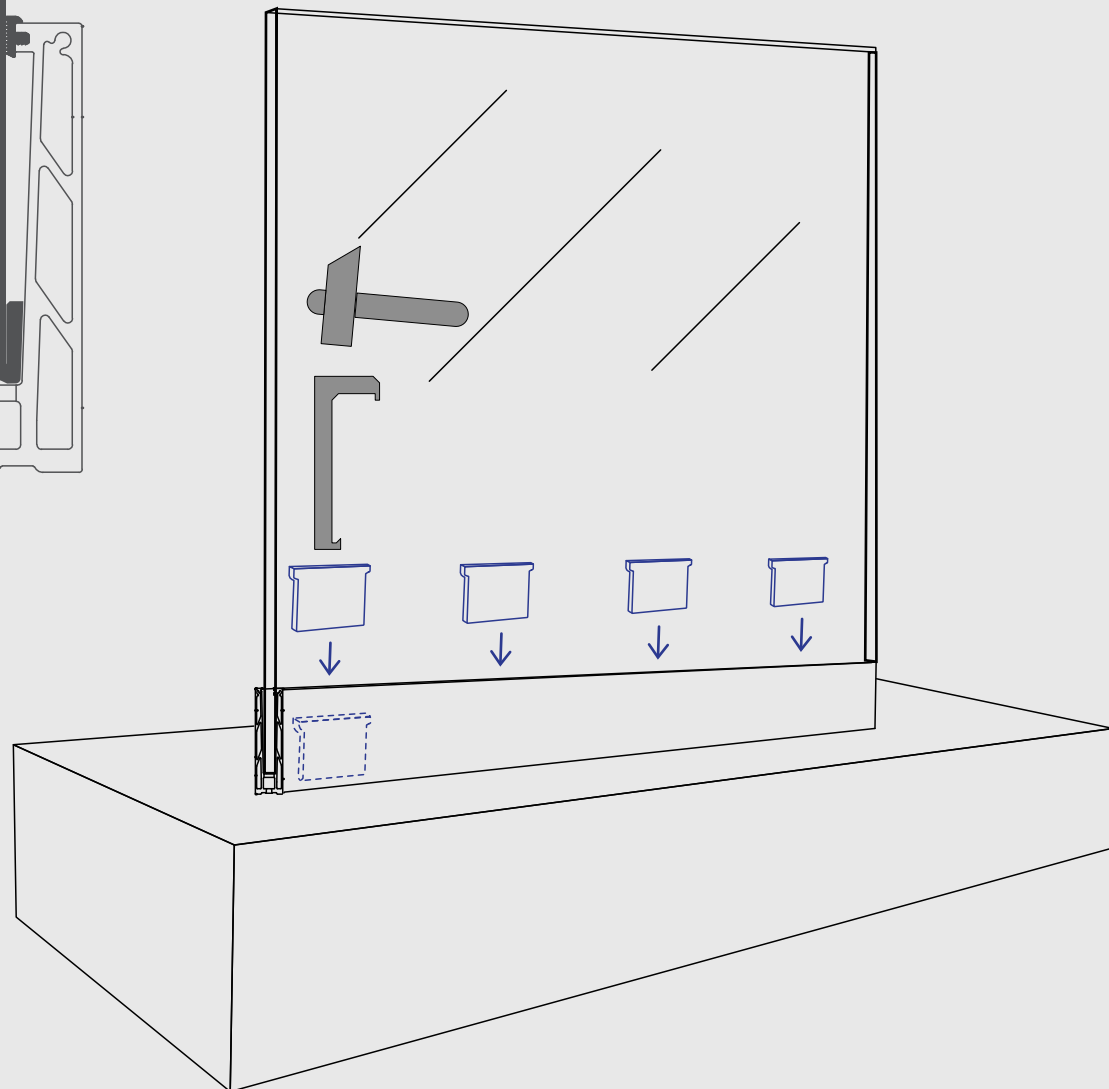
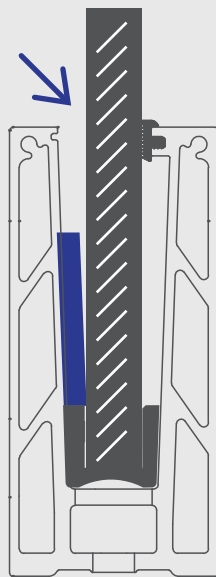

IDT GLASSKINNE TOPPMONTERT

8

Fest innvendig
gummlist.
Ikke strekk gummlisten
under montasje!

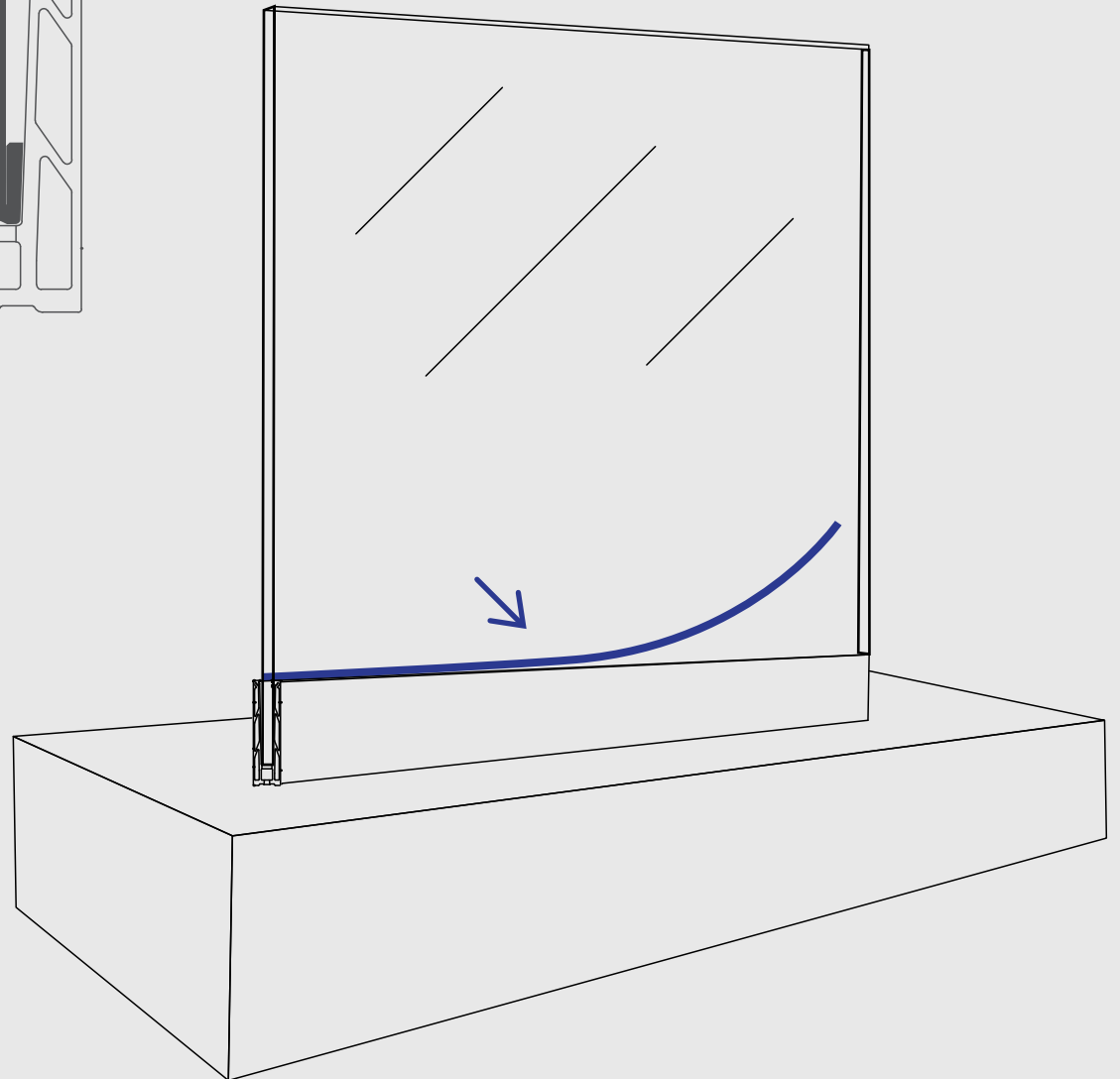
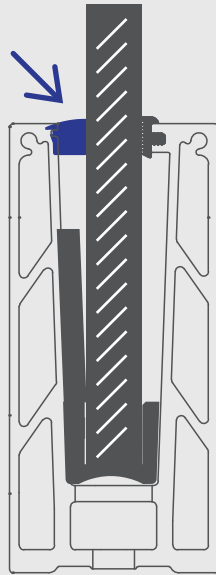

IDT GLASSKINNE TOPPMONTERT

8

Fest profildeksel med
medfølgende popnagler.

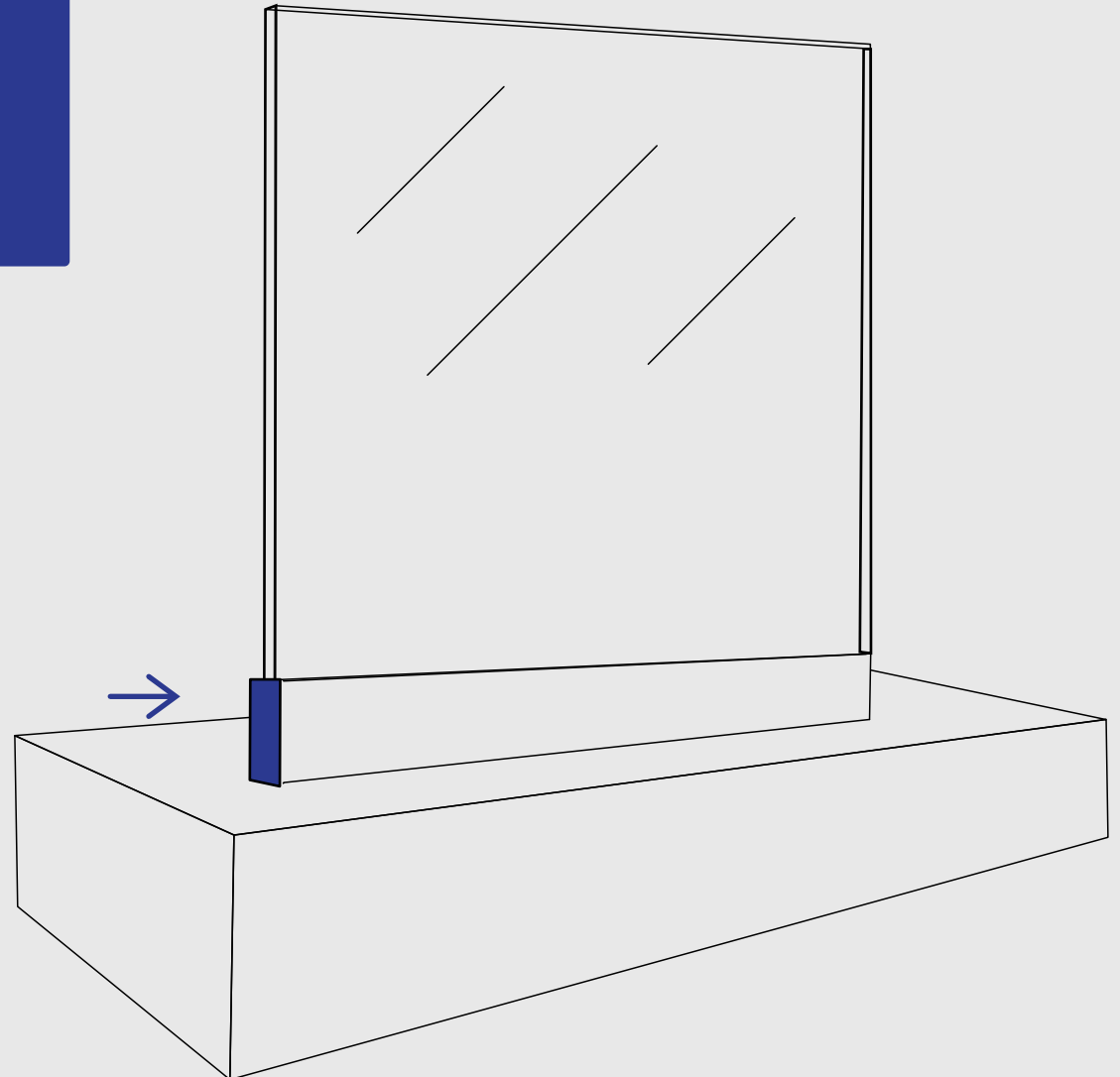
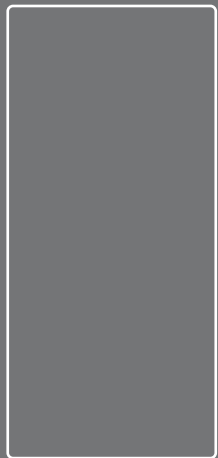

IDT GLASSKINNE TOPPMONTERT

9

Fest gummilist på toppen
av det monterte glasset.

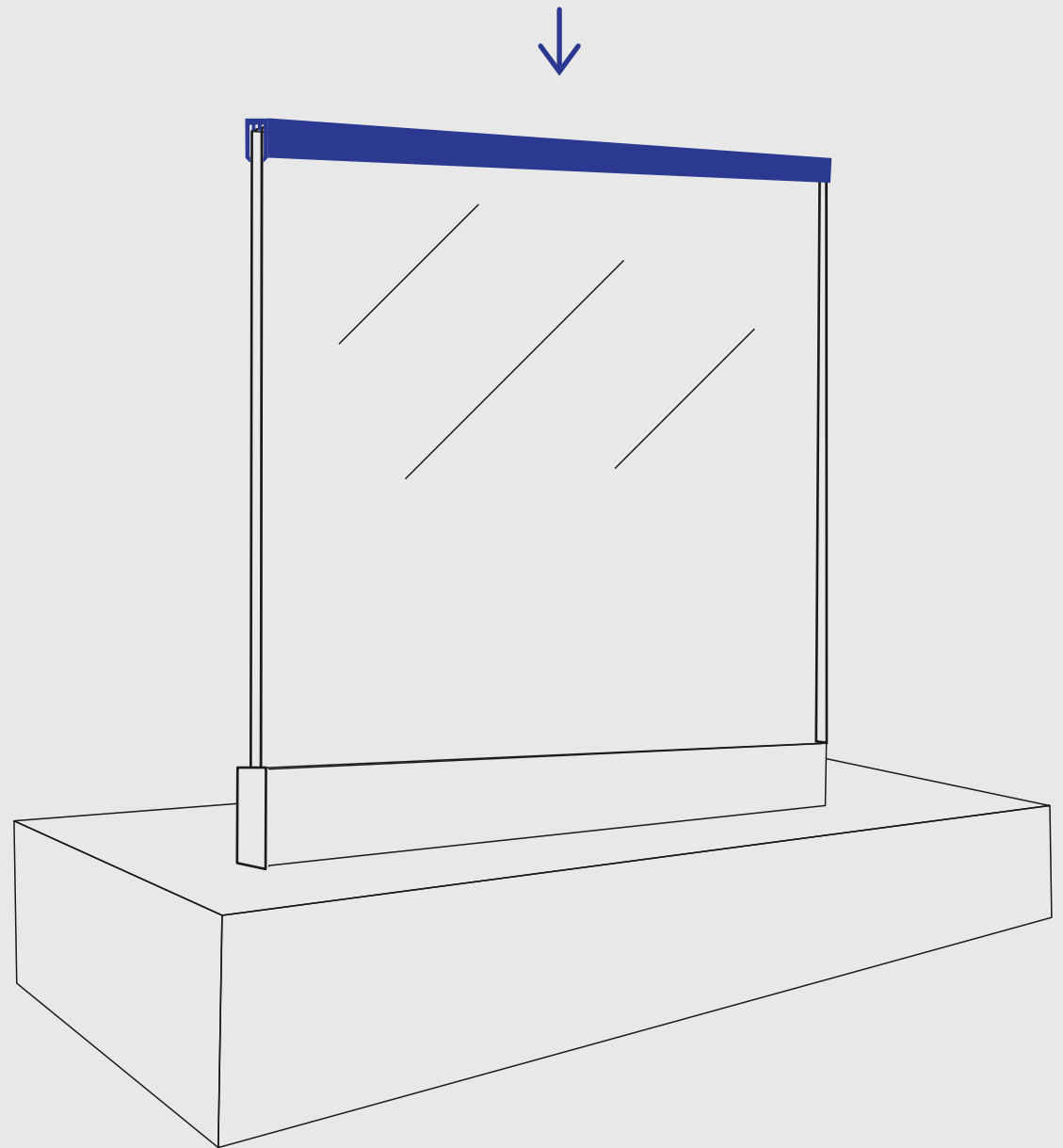

IDT GLASSKINNE TOPPMONTERT

10

Fest håndløperen på toppen av gummilisten. Bruk gjerne vinduspyler-væske eller Zalo-vann på topp av gummilist og invendig i håndløper.

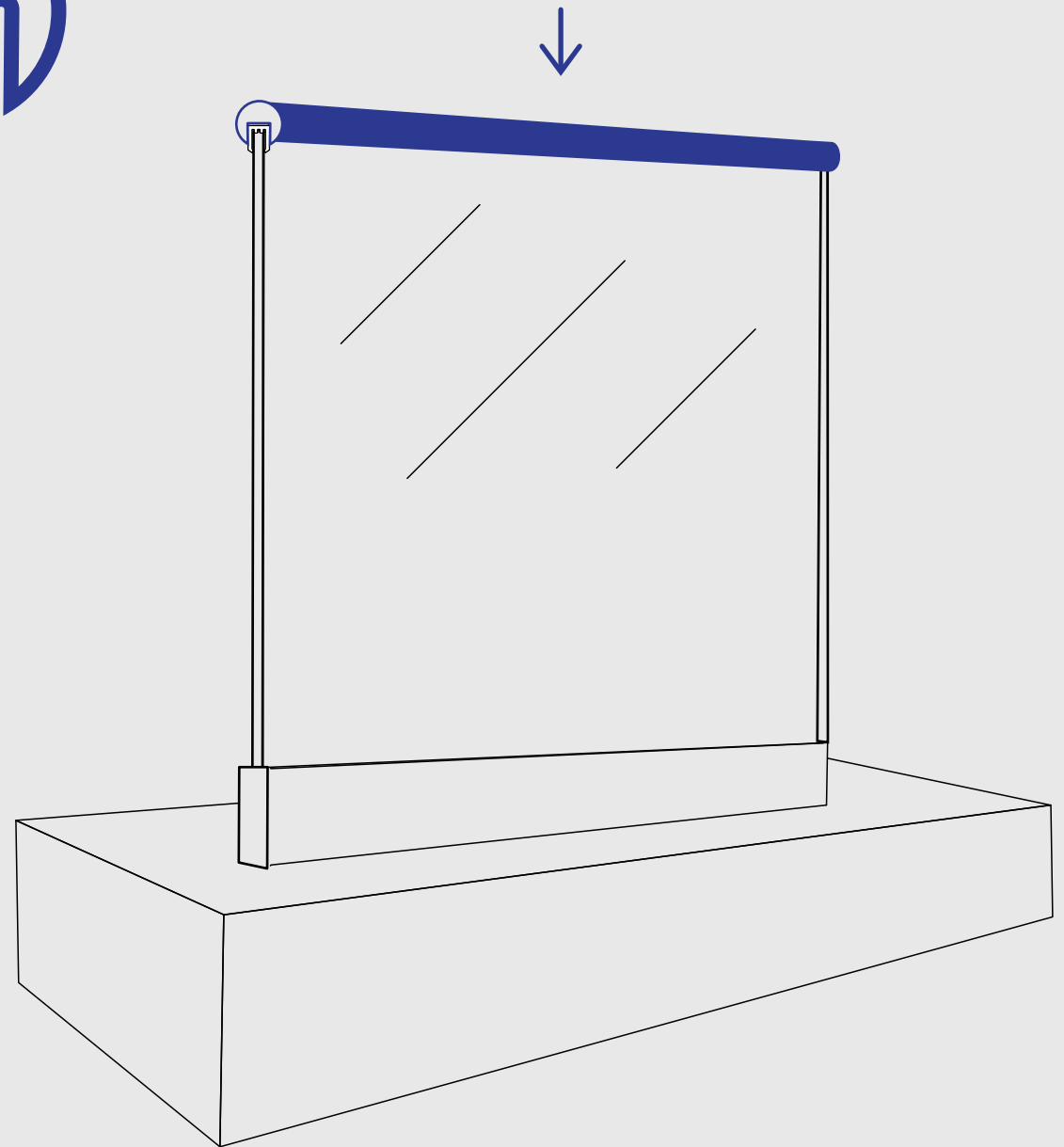

IDT GLASSKINNE TOPPMONTERT

10

Fest endelokk med
gummiklubbe.

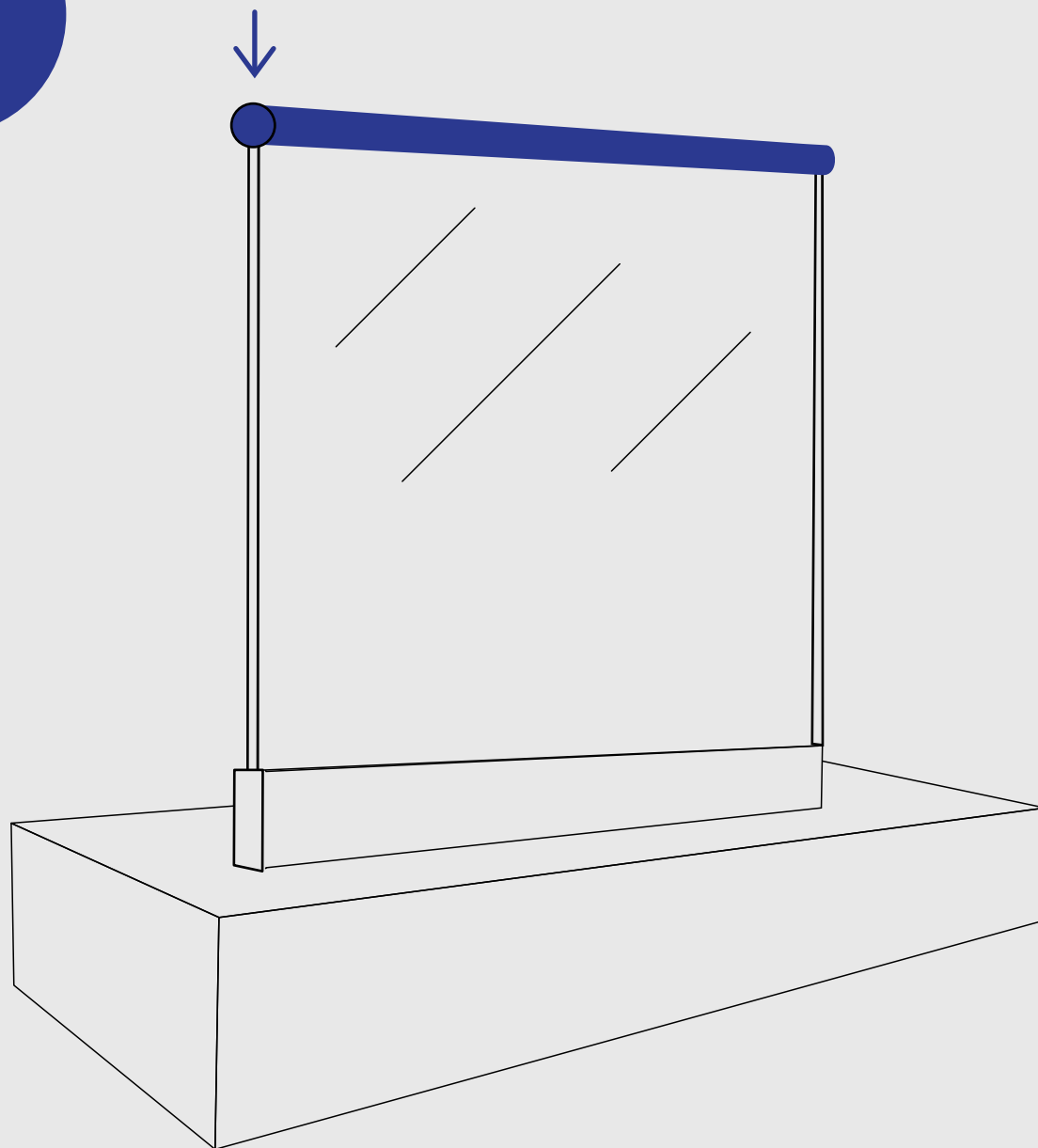
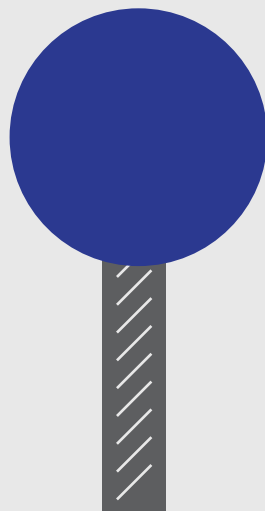
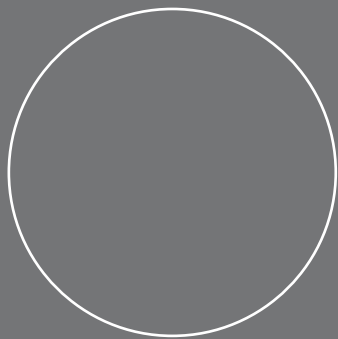



IDT Solutions AS
Lenagata 133, 2850 Lena

Produksjon
Øverskreien 155, 2850 Lena

Telefon: +47 611 65 260
E-post: post@idt.no

